

System 3R – Tooling, automation and software

10 Automation examples

with Mikron MILL

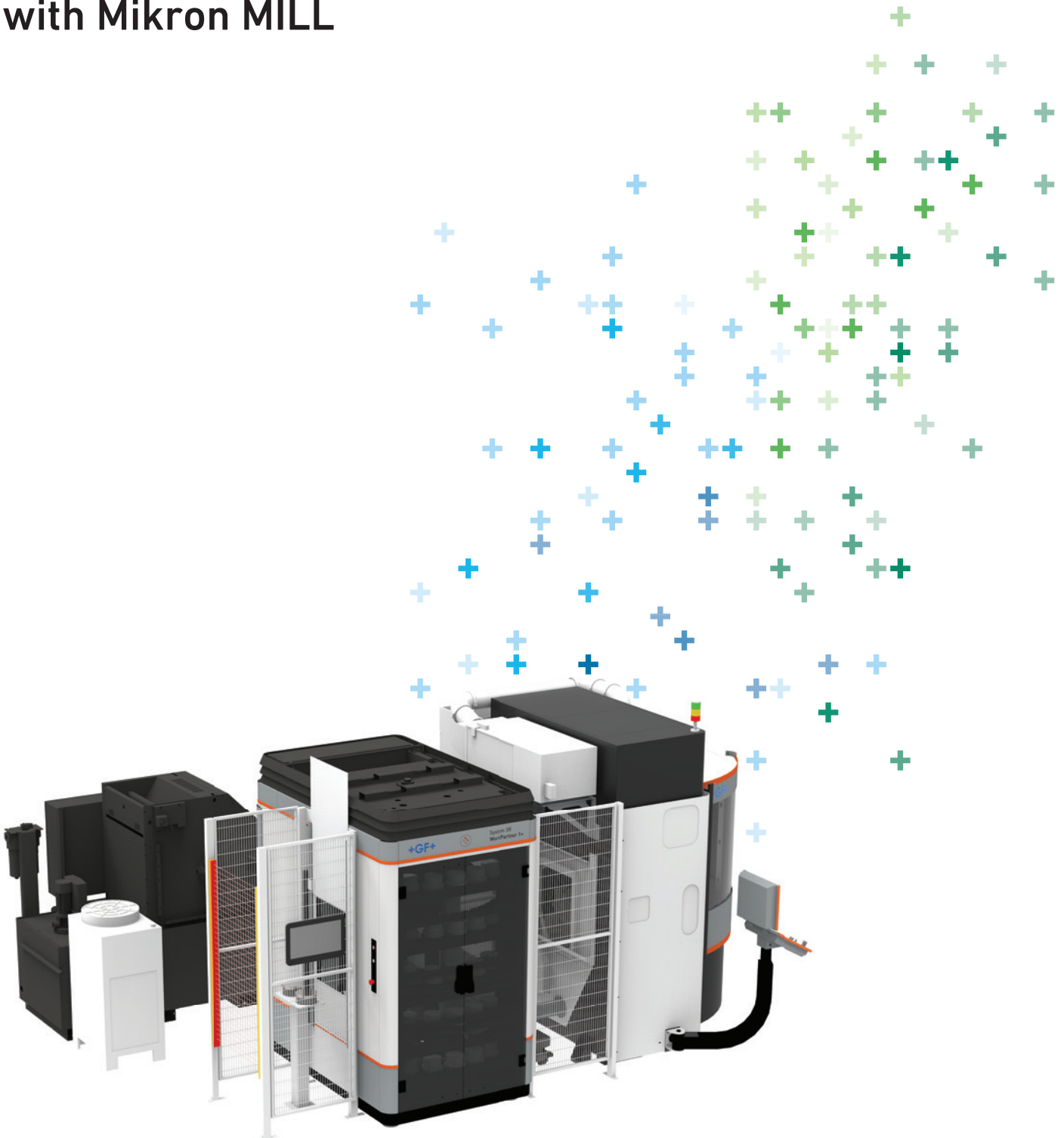

Becoming better every day – since 1802

GF Machining Solutions

When all you need is everything, it's good to know that there is one company that you can count on to deliver complete solutions and services. From unmatched Electrical Discharge Machining (EDM), Laser texturing, Laser micromachining, Additive Manufacturing and first-class Milling and Spindles to Tooling and Automation, all of our solutions are backed by unrivaled Customer Services and expert GF Machining Solutions training. Our AgieCharmilles, Microlution, Mikron Mill, Liechti, Step-Tec and System 3R technologies help you raise your game – and our digital business solutions for intelligent manufacturing, offering embedded expertise and optimized production processes across all industries, increase your competitive edge.

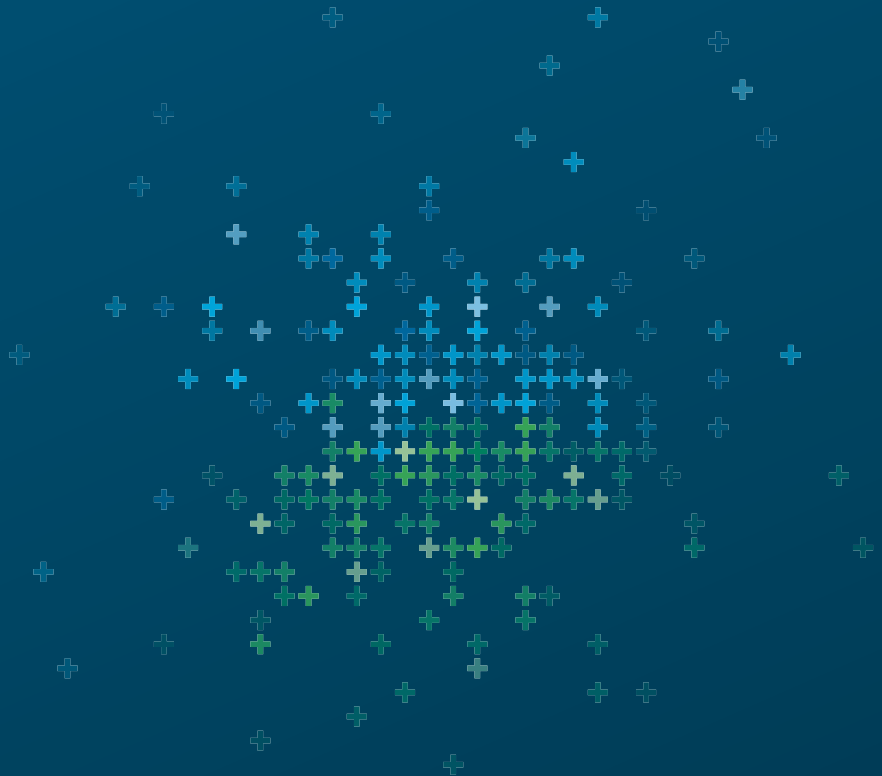

+ We are System 3R.
We are GF Machining Solutions.

Contents

4 Automation examples

9 Calculation examples

10 Scalable automation

12 WorkShopManager

14 About GF Machining Solutions

16 Our customer services

Automation for increased competitiveness

To stay competitive, our customers must be able to keep up. Palletisation is a major element in success; automation is essential for competitiveness. With System 3R, taking the step to automating and streamlining production is far easier than is often imagined.

In this catalogue we only show a few examples with tooling and automation. A second tooling system can be reached through adapters. For other requestes please contact your nearest System 3R consultant.

Automation cell 1 Mikron MILL and System 3R WorkPartner 1+

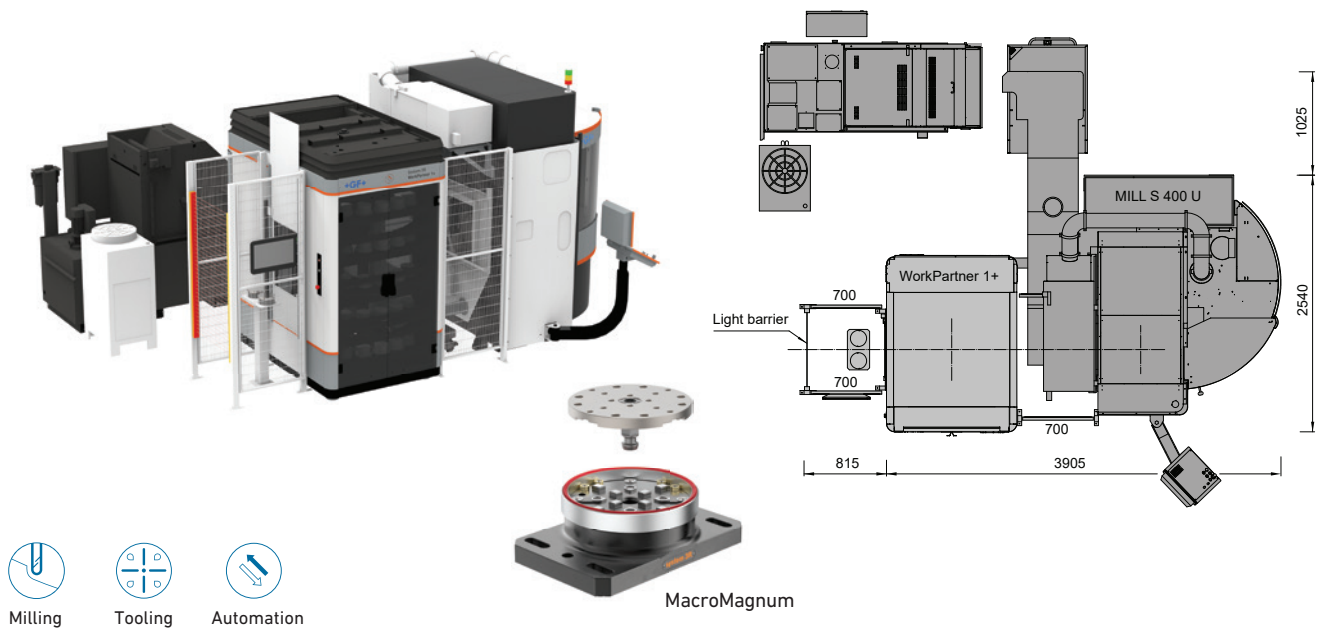

Milling



Tooling



Automation

MacroMagnum

Machine type	Robot model	Magazine (robot)	Tooling	Workpiece size*	Weight**
Mikron MILL S 400 U	System 3R WorkPartner 1+	Light magazine 2 pieces And Loading station	MacroMagnum 40 pos (20 pos./magazine)	155 x 155 x 220 mm	25 kg

Automation cell 2 Mikron MILL and System 3R Transformer WorkMaster

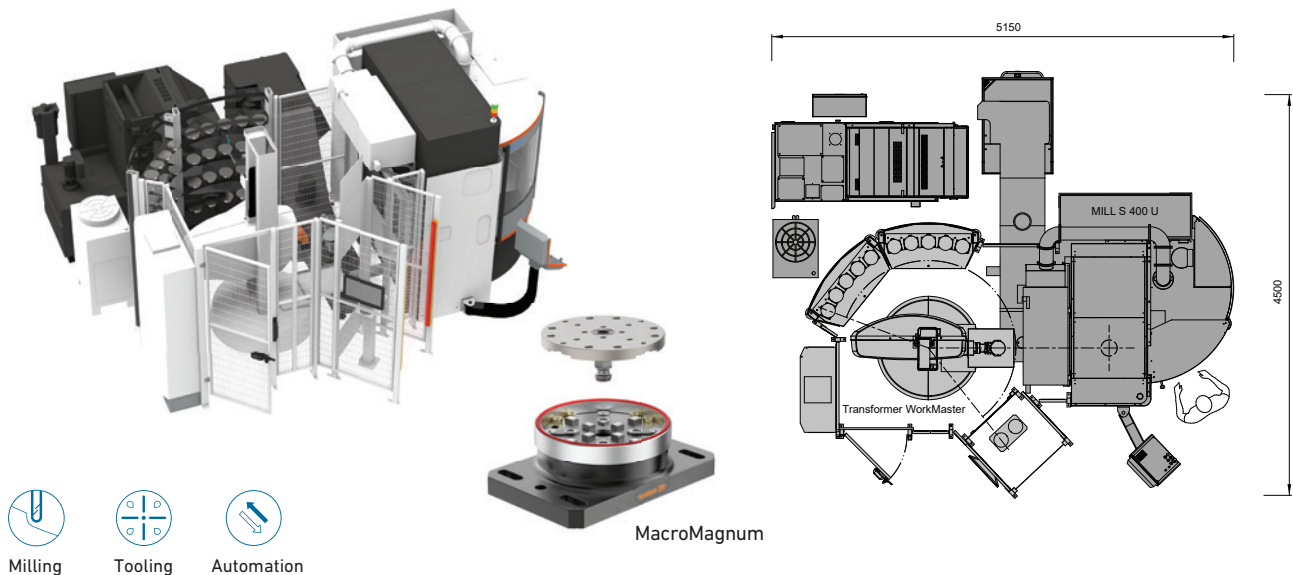

Milling



Tooling



Automation

MacroMagnum

Machine type	Robot model	Magazine (robot)	Tooling	Workpiece size*	Weight**
Mikron MILL S 400 U	System 3R Transformer WorkMaster (1500/100)	Rack magazine 2 pieces And Loading station	MacroMagnum 50 pos (25 pos./magazine)	155x 155 x 200 mm	25 kg

* Width x depth x height. **Maximum weight limited by suggested tooling (including gripper, pallet, etc).

Note: Ask for suitable software package.

Automation cell 3 Mikron MILL and System 3R WorkPartner 1+

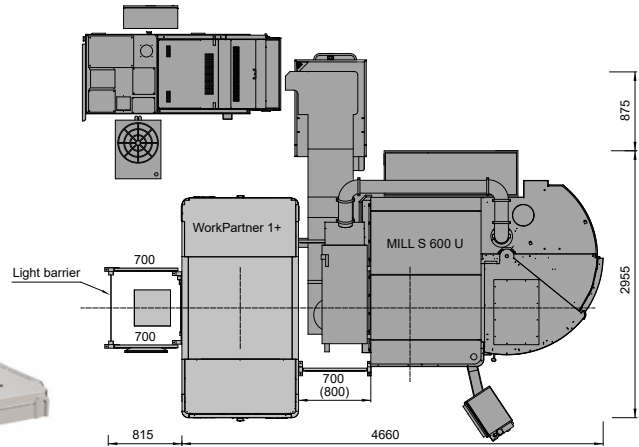

Milling



Tooling



Automation

Dynafix

Machine type	Robot model	Magazine (robot)	Tooling	Workpiece size*	Weight**
Mikron MILL S 600 U	System 3R WorkPartner 1+	Heavy magazine 2 pieces And Loading station	Dynafix 20 pos (10 pos./magazine)	350 x 350 x 200 mm	80 kg

Automation cell 4 Mikron MILL and System 3R Transformer WorkMaster

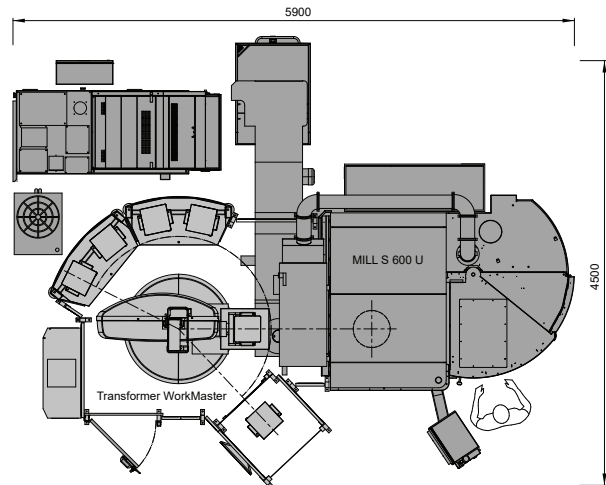

Milling



Tooling



Automation

Dynafix

Machine type	Robot model	Magazine (robot)	Tooling	Workpiece size*	Weight**
Mikron MILL S 600 U	System 3R Transformer WorkMaster (1500/150)	Rack magazine 2 pieces And Loading station	Dynafix 20 pos (10 pos./magazine)	350 x 350 x 200 mm	120 kg

* Width x depth x height. **Maximum weight handled (including gripper, pallet, etc).

Note: Ask for suitable software package.

Automation cell 5 Mikron MILL and System 3R Transformer 6-Axis robot

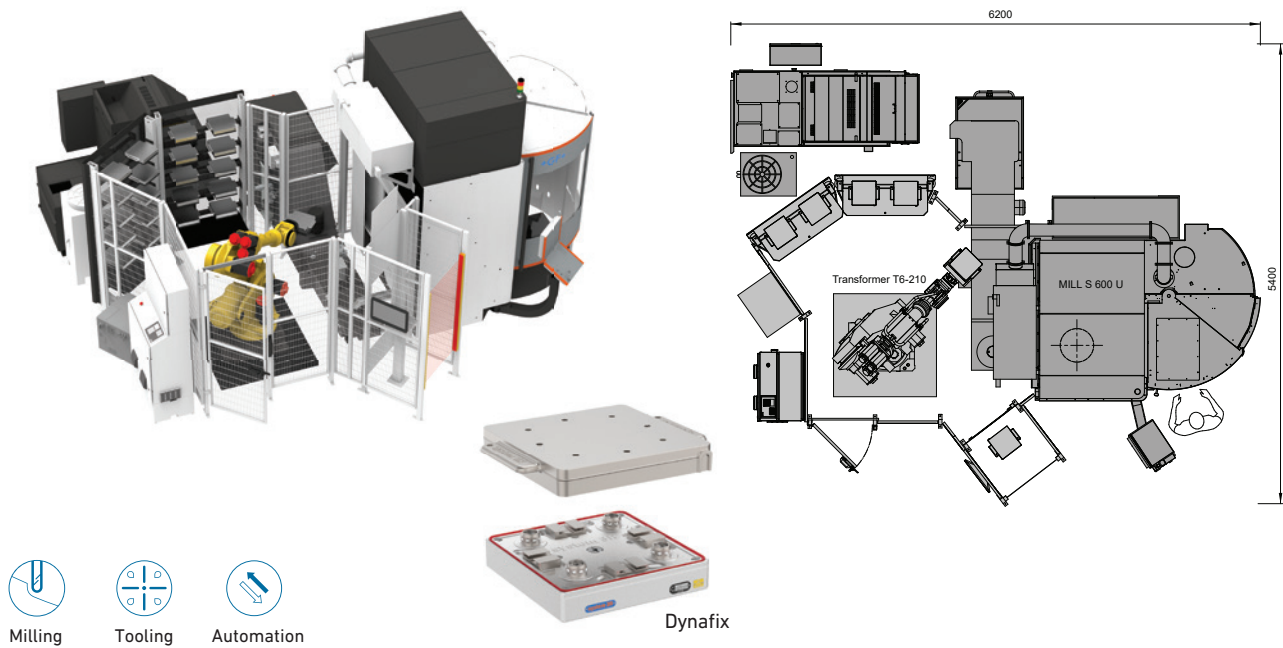

Machine type	Robot model	Magazine (robot)	Tooling	Workpiece size*	Weight**
Mikron MILL S 600 U	System 3R Transformer 6-Axis robot (T6-210)	Rack magazine 2 pieces And Loading station	Dynafix 20 pos (10 pos./magazine)	350 x 350 x 200 mm	120 kg

Automation cell 6 Mikron MILL and System 3R WorkPartner 1+

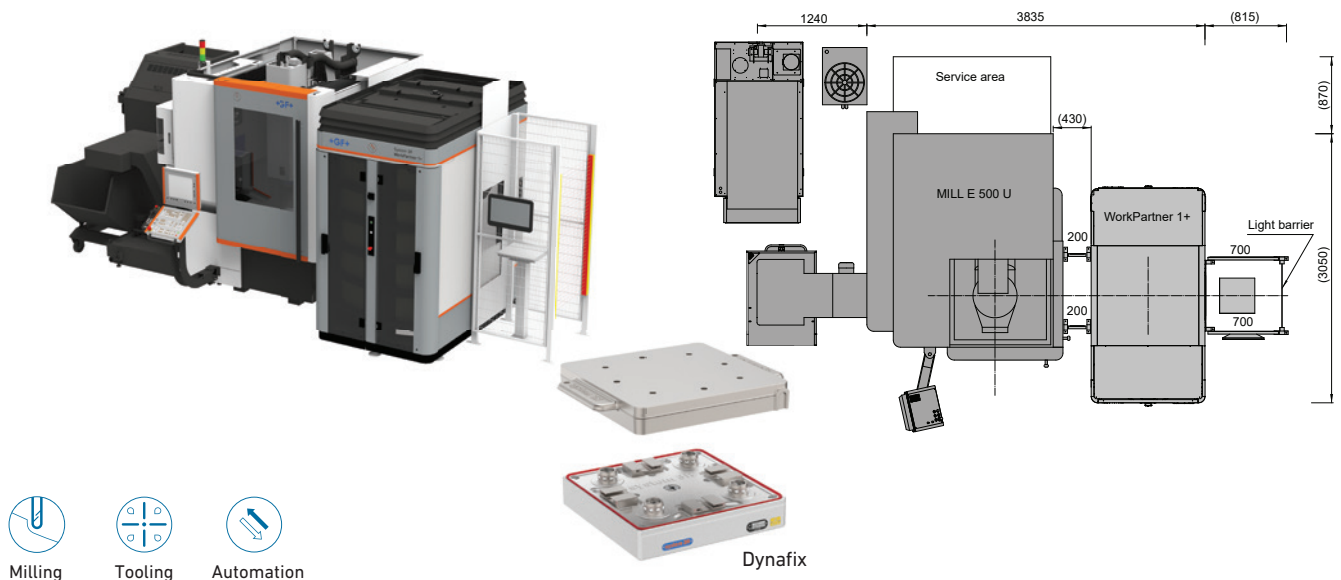

Machine type	Robot model	Magazine (robot)	Tooling	Workpiece size*	Weight**
Mikron MILL E 500 U	System 3R WorkPartner 1+	Heavy magazine 2 pieces And Loading station	Dynafix 20 pos (10 pos./magazine)	400 x 400 x 200 mm	80 kg

* Width x depth x height. **Maximum weight handled (including gripper, pallet, etc).

Note: Ask for suitable software package.

Automation cell 7 Mikron MILL and System 3R Transformer WorkMaster

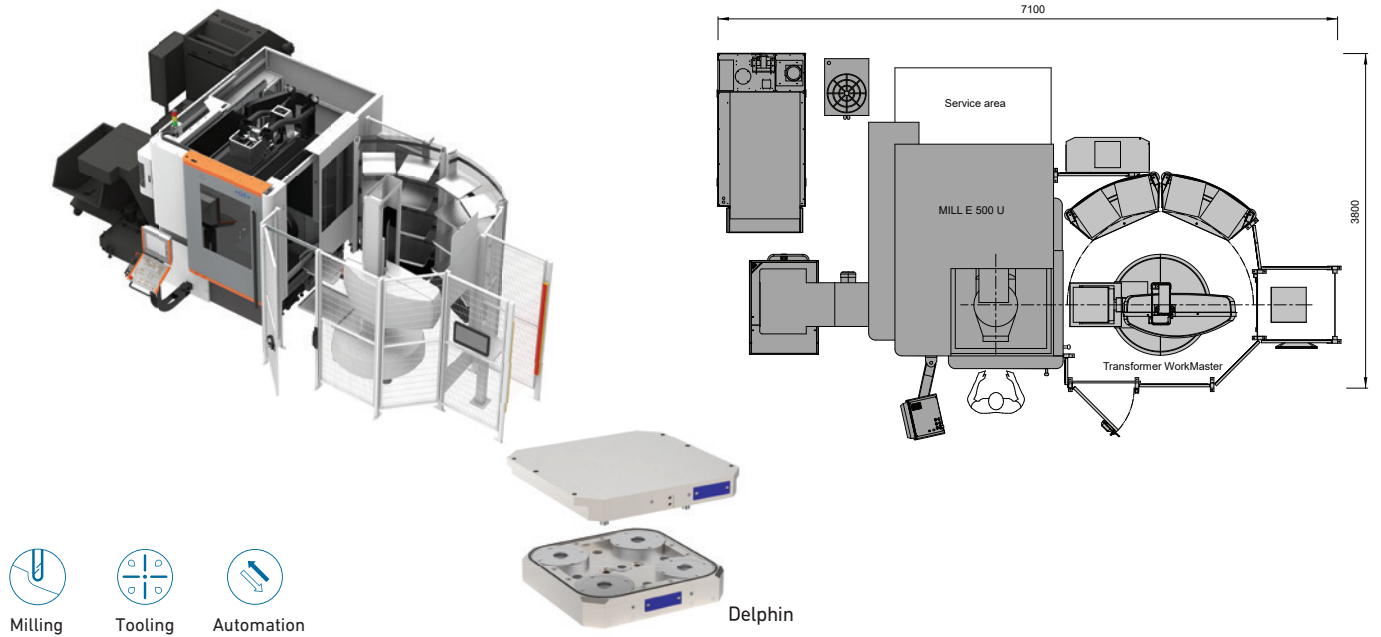

Machine type	Robot model	Magazine (robot)	Tooling	Workpiece size*	Weight**
Mikron MILL E 500 U	System 3R Transformer WorkMaster (1500/150)	Rack magazine 2 pieces And Loading station	Delphin 16 pos (8 pos./magazine)	400 x 400 x 300 mm	150 kg

Automation cell 8 Mikron MILL and System 3R Transformer WorkMaster

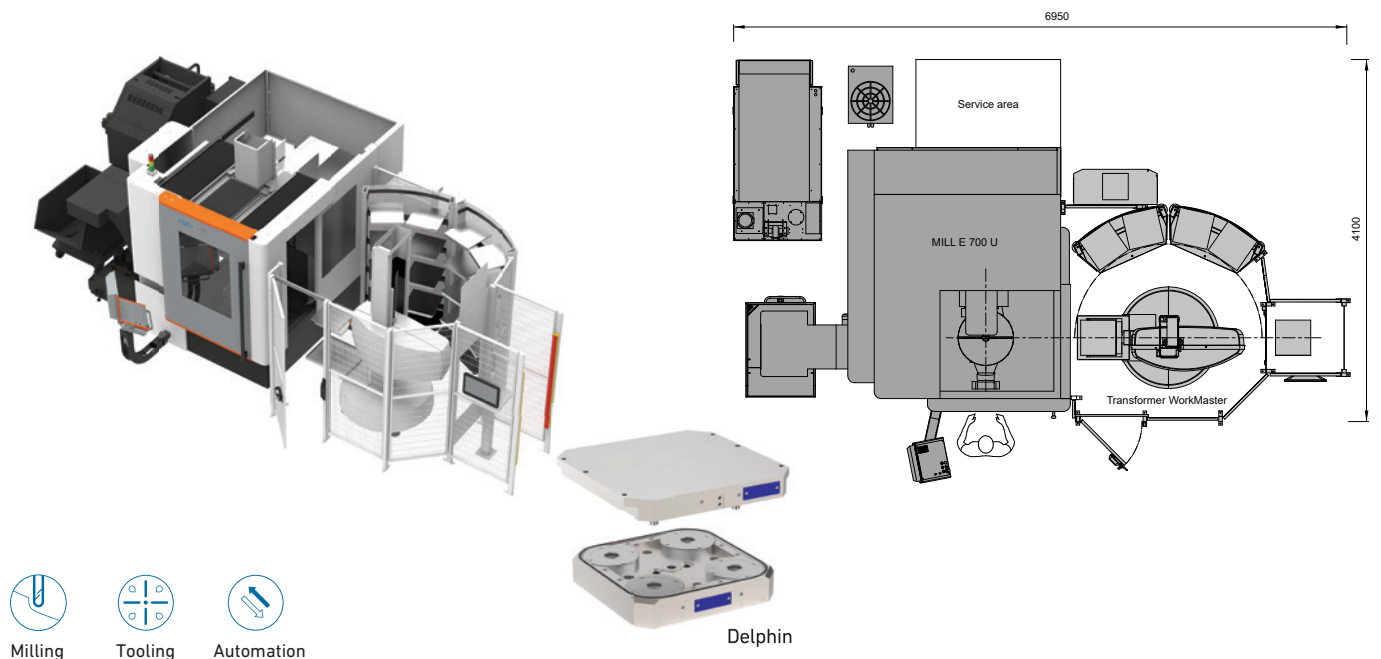

Machine type	Robot model	Magazine (robot)	Tooling	Workpiece size*	Weight**
Mikron MILL E 700 U	System 3R Transformer WorkMaster (1500/150)	Rack magazine 2 pieces And Loading station	Delphin 16 pos (8 pos./magazine)	400 x 400 x 300 mm	150 kg

*Width x depth x height. **Maximum weight handled (including gripper, pallet, etc).

Note: Ask for suitable software package.

Automation cell 9 Mikron MILL and System 3R Transformer 6-Axis robot

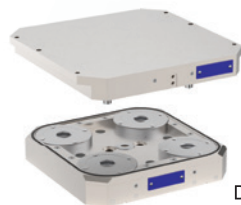
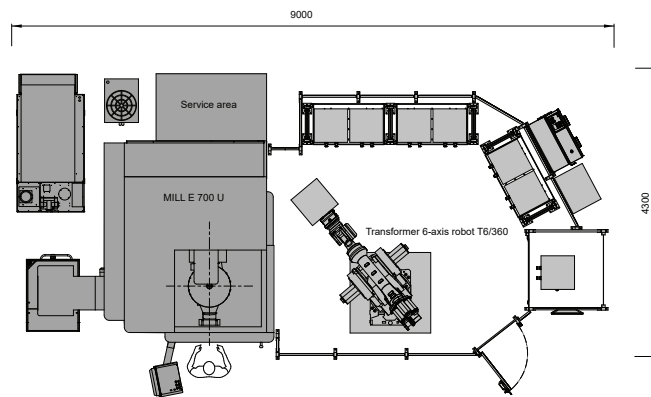

Delphin



Milling



Tooling



Automation

Machine type	Robot model	Magazine (robot)	Tooling	Workpiece size*	Weight**
Mikron MILL E 700 U	System 3R Transformer 6-Axis robot (T6-360)	Rack magazine 3 pieces And Loading station	Delphin 18 pos (6 pos./magazine)	500 x 500 x 500 mm	360 kg

Automation cell 10 Mikron MILL and System 3R Transformer 6-Axis robot

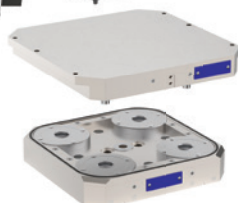
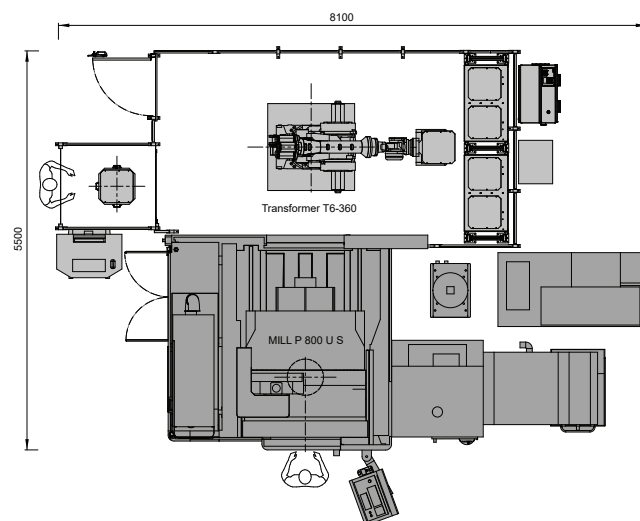

Delphin



Milling



Tooling



Automation

Machine type	Robot model	Magazine (robot)	Tooling	Workpiece size*	Weight**
Mikron MILL P 800 U S	System 3R Transformer 6-Axis robot (T6-360)	Rack magazine 2 pieces And Loading station	Delphin 16 pos (8 pos./magazine)	450 x 450 x 400 mm	360 kg

*Width x depth x height. **Maximum weight handled (including gripper, pallet, etc).

Note: Ask for suitable software package.

Calculation examples

One manned shift – eight hours (5 days per week)

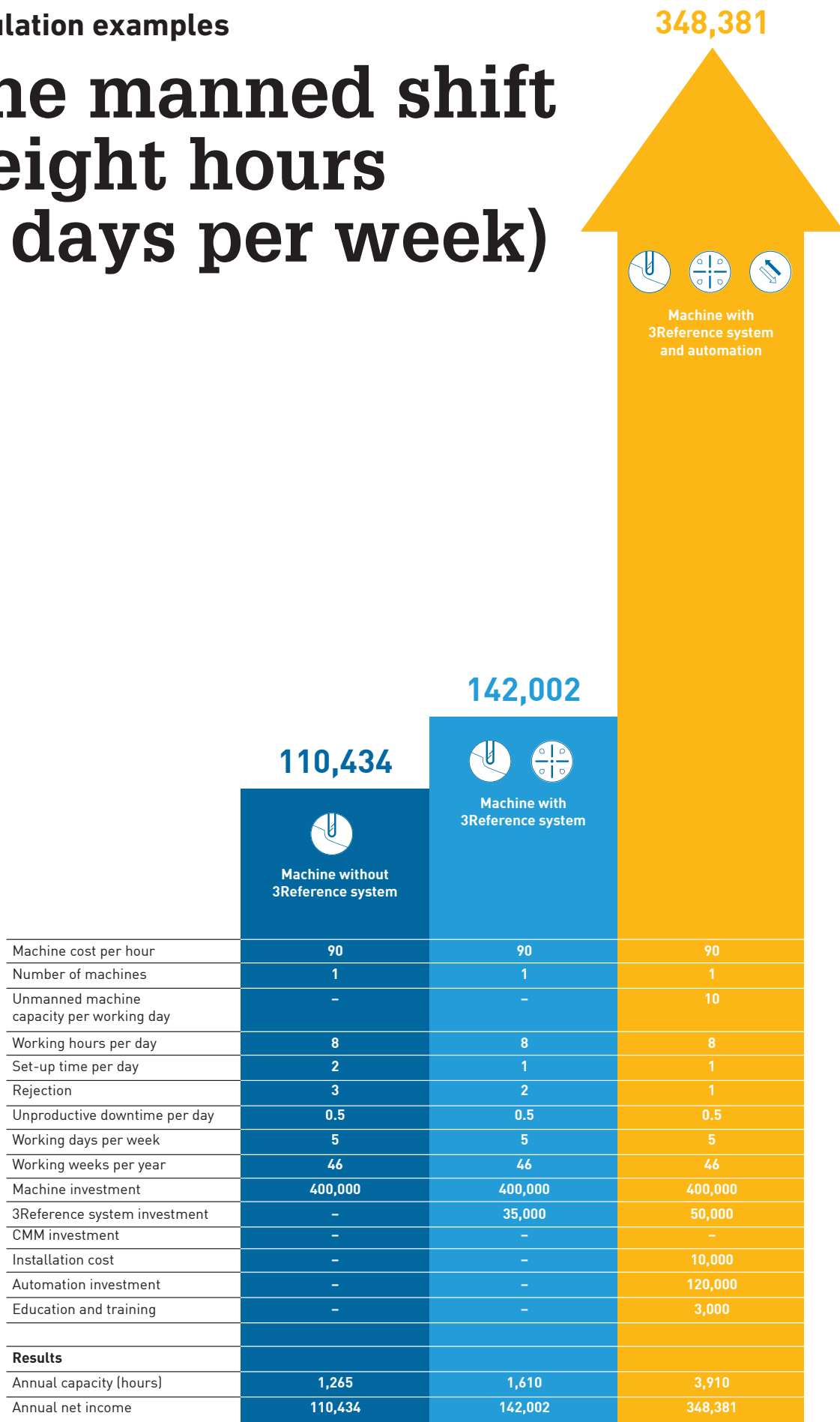

Scalable automation

Grows with your needs

6-axis Transformer on rail
70 - 700 kg transfer weights.

Rail
Aluminium: Up to 20 m long.
Steel: Up to 30 m long.

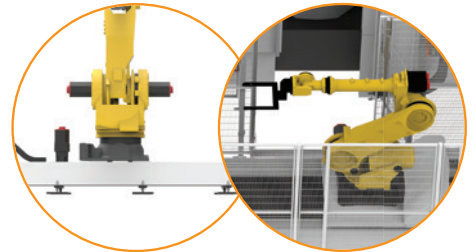

Milling machine

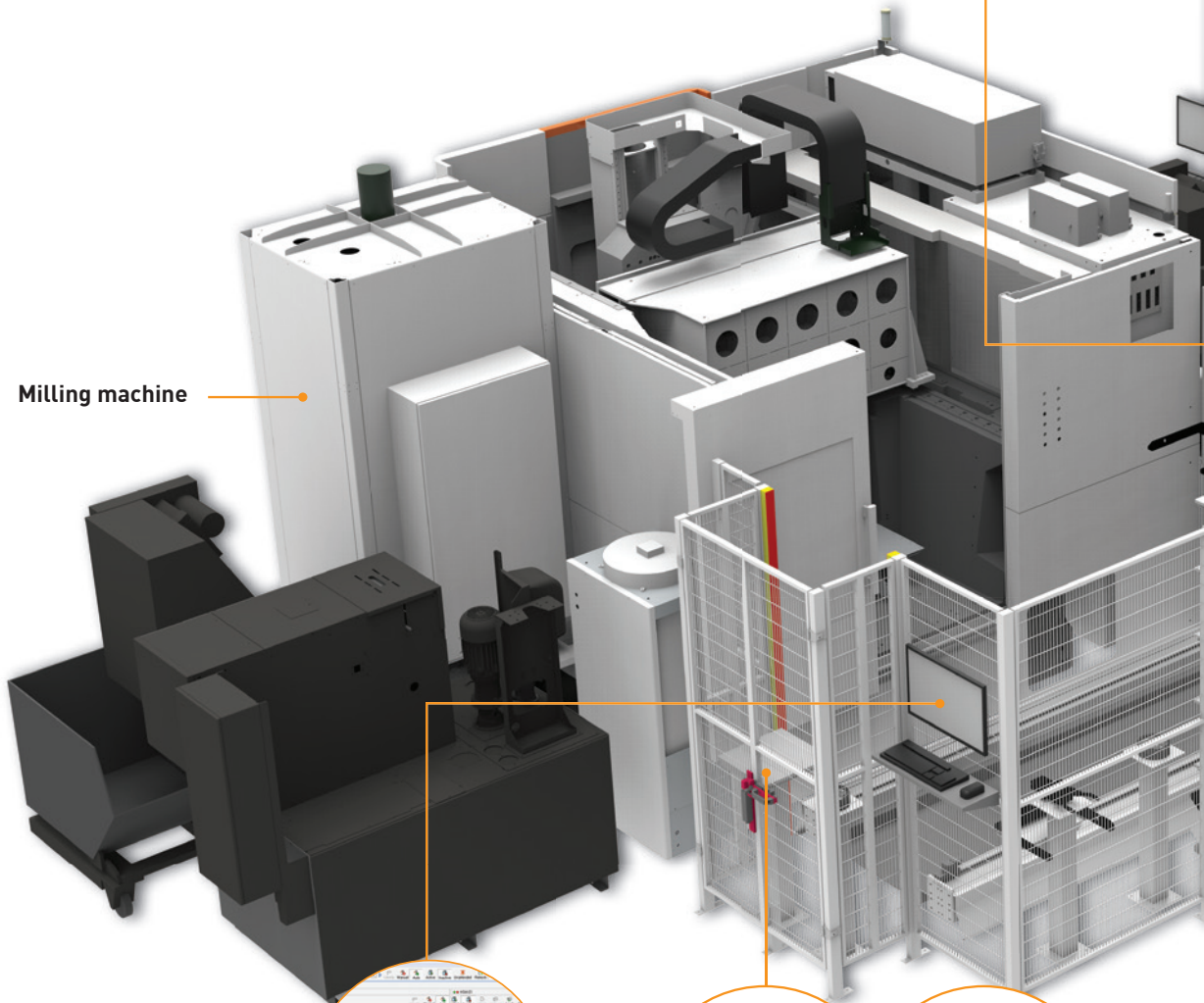

Software
WSM – WorkShopManager
Supports 1 - 12 machines in a cell.
Wire EDM, EDM, MILL, laser and CMM.

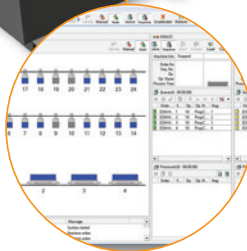

Loading station or ULD station

Load and unload parts without stopping the automation cell.
In this case, prepared MacroMagnum and Dynafix pallets.

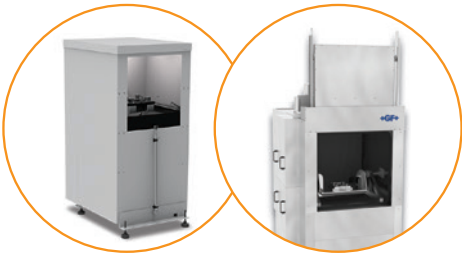

Options
Draining station and washing machine.

Milling machine



Rotary magazine (x 3)
Large capacity in a small footprint. In this case, equipped with Macro and MacroMagnum pallets.

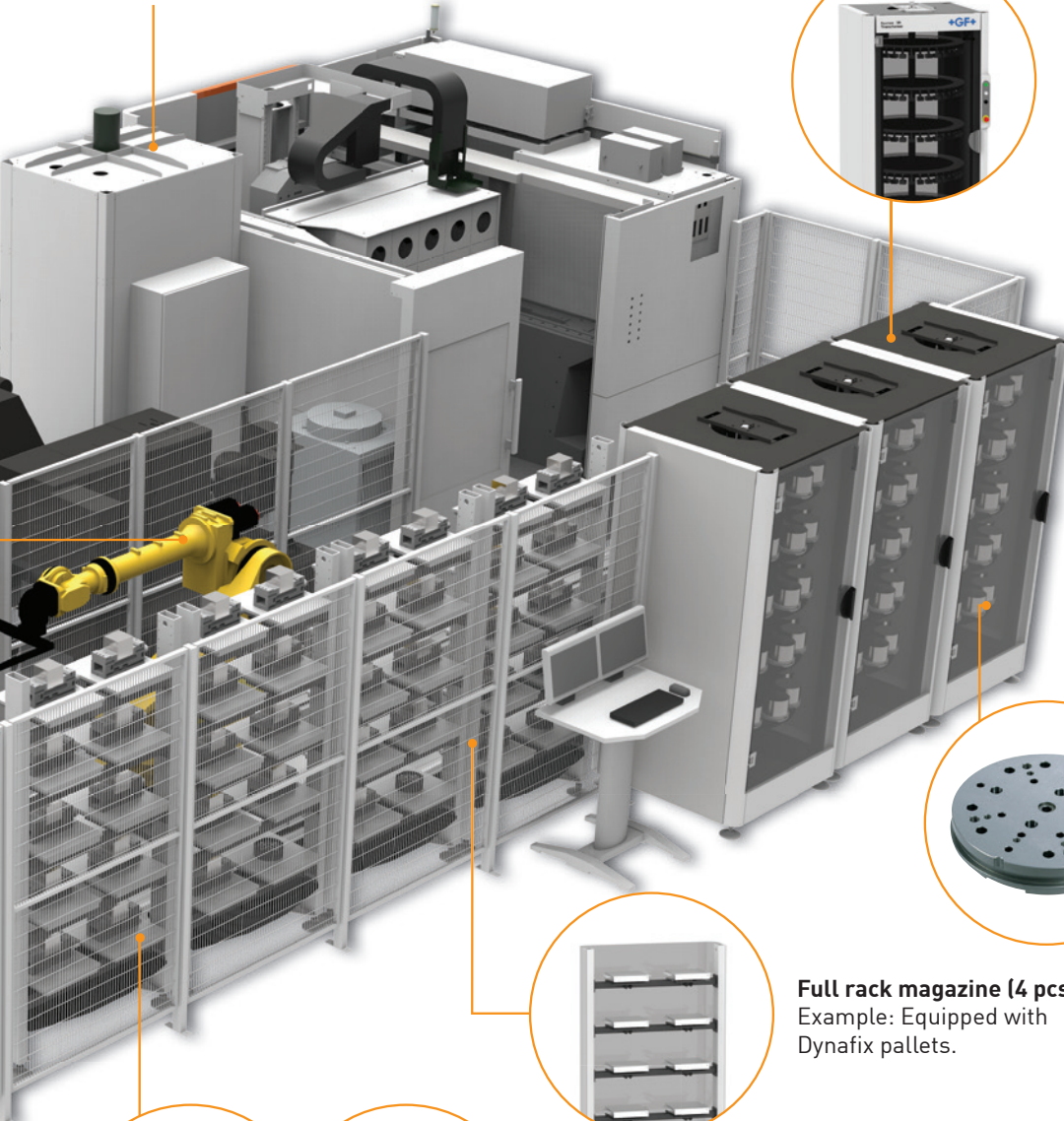

Pallets
Example: Macro and MacroMagnum.



Full rack magazine (4 pcs.)
Example: Equipped with Dynafix pallets.

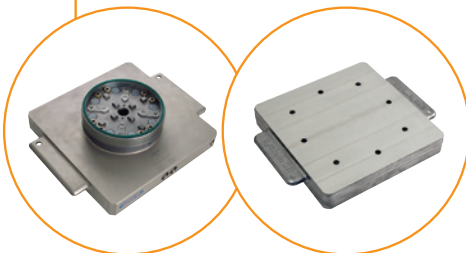

Adapter plates and pallets
Example: MacroMagnum and Dynafix.

Note: The picture is an example and the very same as we use at System 3R production plant.

Work smarter, not harder

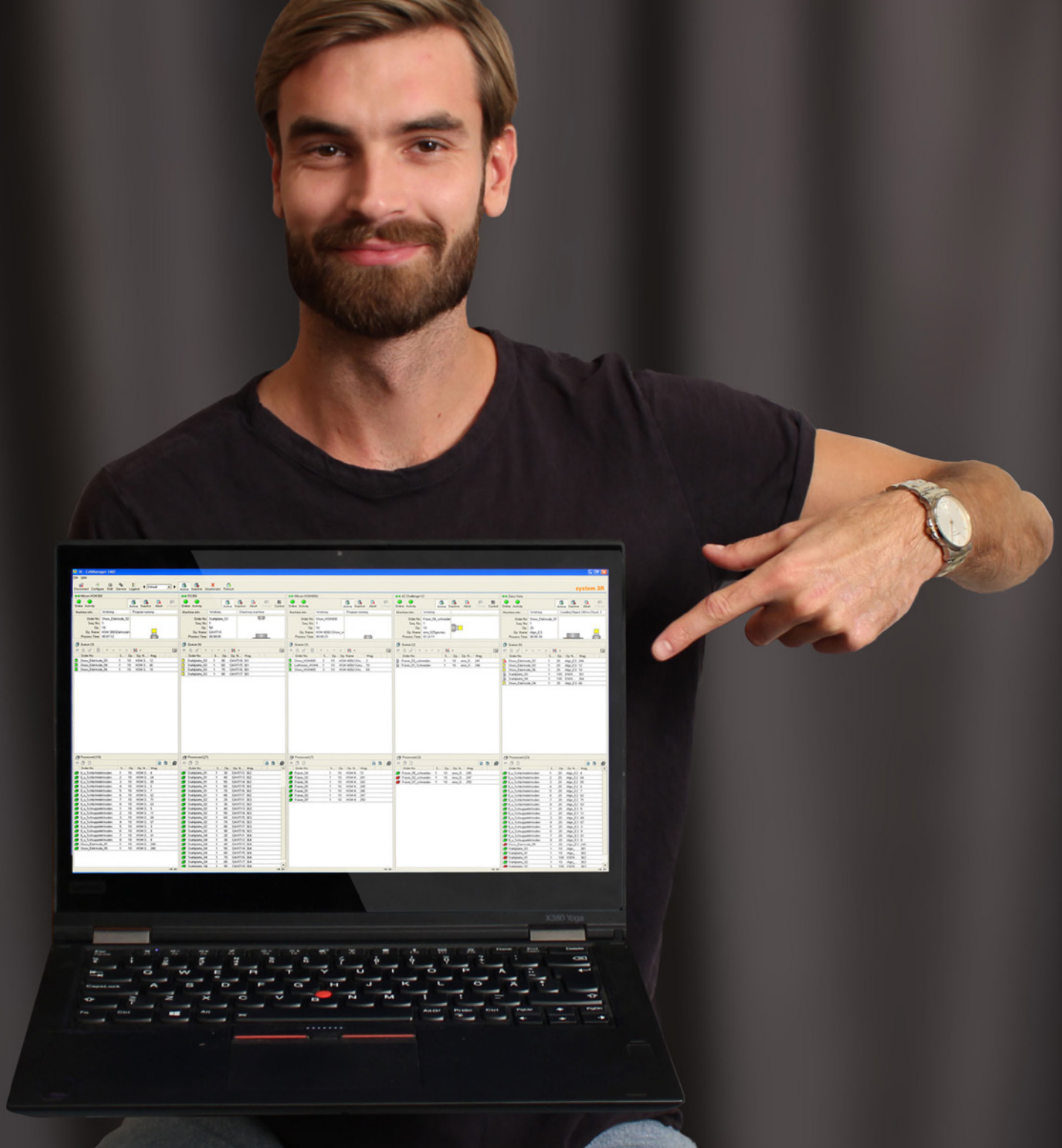

WorkShopManager

Seamless integration of all your processes

- + Quick and accurate overview of the entire process chain
- + Management of the entire automation process
- + Human errors drastically reduced
- + Process safety and reliability.

WorkShopManager

Grows with your needs

- + Easy-to-learn and user friendly
- + Brings all your production technologies together in one process chain
- + Keeps your production running with standardised procedures
- + Manages your automated processes
- + Designed for your future (new machines, magazines and options can be added later on)
- + Central database for the entire factory.

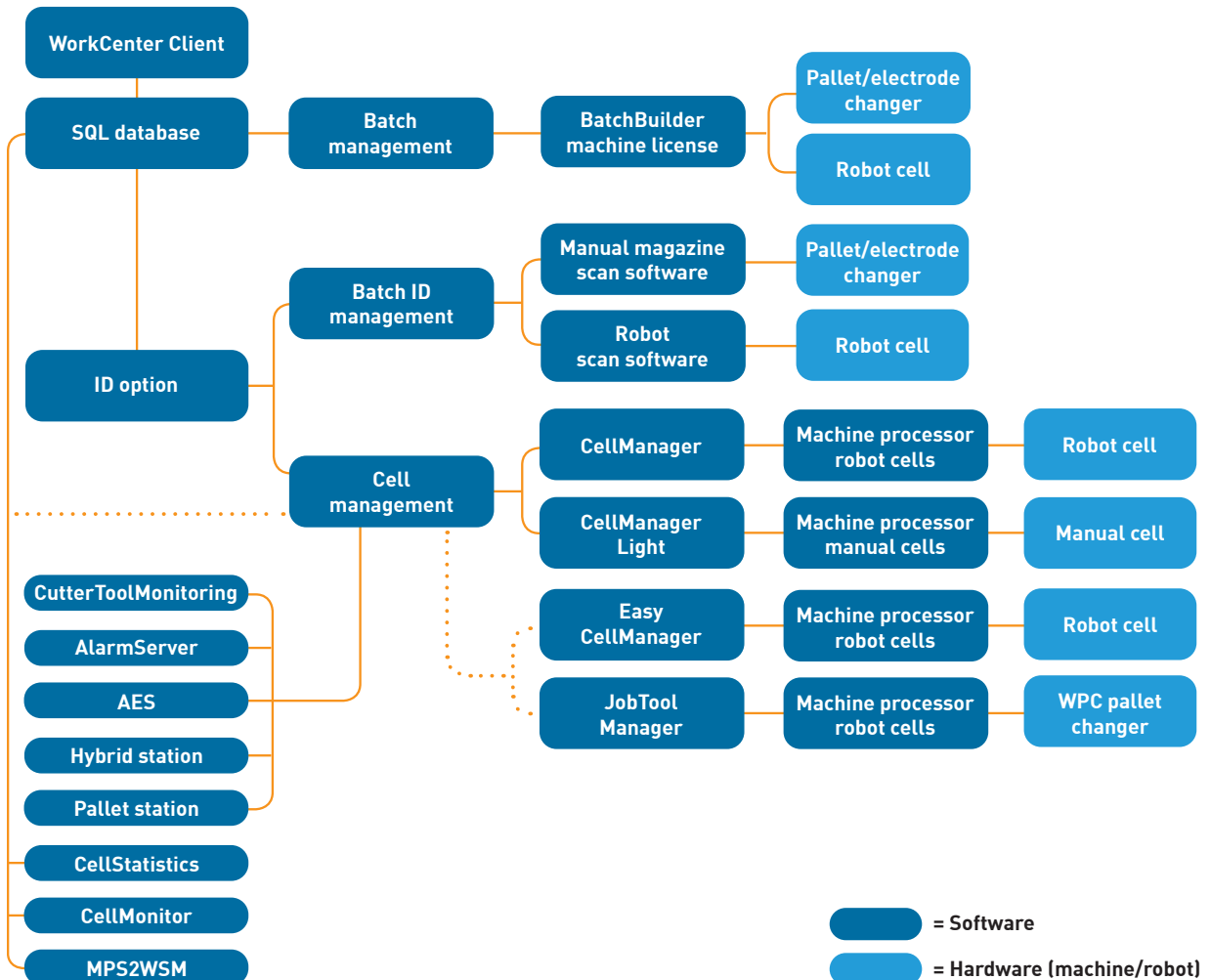

About GF Machining Solutions

Multi-technology solutions provider

Our commitment to you and your specific applications is proven by the value-adding intelligence, productivity and quality delivered by our multi-technology solutions. Your success is our chief motivator. That's why we are continuously advancing our legendary technical expertise. Wherever you are, whatever your market segment and whatever the size of your operation, we have the complete solutions and the customer-centric commitment to accelerate your success—today.

EDM (Electrical Discharge Machining)



Wire-cutting EDM

GF Machining Solutions' wire-cutting EDM is fast, precise and increasingly energy efficient. From ultraprecise machining of miniaturized components down to 0.02 mm to powerful solutions for demanding high-speed machining with respect to surface accuracy, our wire-cutting EDM solutions position you for success.

Die-sinking EDM

GF Machining Solutions is revolutionizing die-sinking EDM with features like iGAP technology to dramatically boost machining speed and reduce electrode wear. All of our die-sinking systems offer fast removal and deliver mirror finishes of Ra 0.1 µm (4 µin).

Hole-drilling EDM

GF Machining Solutions' robust hole-drilling EDM solutions enable you to drill holes in electrically conductive materials at a very high speed—and, with a five-axis configuration, at any angle on a workpiece with an inclined surface.

Milling



Milling

Precision tool and mold manufacturers enjoy a competitive edge with our Mikron MILL S solutions' fast and precise machining. The Mikron MILL P machines achieve above-average productivity thanks to their high performance and Automation. Customers seeking fastest return on investment benefit from the affordable efficiency of our MILL E solutions.

High-performance Airfoil Machining

Our Liechti turnkey solutions enable the highly dynamic manufacturing of precision airfoils. Thanks to the unique performance and our expertise in airfoil machining, you increase productivity by producing at the lowest cost per part.

Spindles

As part of GF Machining Solutions, Step-Tec is engaged in the very first stage of each machining center development project. Compact design combined with excellent thermal and geometric repeatability ensure the perfect integration of this core component into the machine tool.

Advanced manufacturing



Laser texturing

Aesthetic and functional texturing is easy and infinitely repeatable with our digitized Laser technology. Even complex 3D geometries, including precision parts, are textured, engraved, microstructured, marked and labeled.

Laser micromachining

GF Machining Solutions offers the industry's most complete line of Laser micromachining platforms optimized for small, high-precision features to meet the increasing need for smaller, smarter parts to support today's leading-edge products.

Laser Additive Manufacturing (AM)

GF Machining Solutions and 3D Systems, a leading global provider of additive manufacturing solutions and the pioneer of 3D printing, have partnered to introduce new metal 3D printing solutions that enable manufacturers to produce complex metal parts more efficiently.

Tooling and Automation



Tooling

Our customers experience complete autonomy while maintaining extreme accuracy, thanks to our highly accurate System 3R reference systems for holding and positioning electrodes and work pieces. All types of machines can easily be linked, which reduces set-up times and enables a seamless transfer of workpieces between different operations.

Automation

Together with System 3R, we also provide scalable and cost-effective Automation solutions for simple, single machine cells or complex, multi-process cells, tailored to your needs.

Software



Digitalization solutions

To drive its digital transformation, GF Machining Solutions acquired symmedia GmbH, a company specialized in software for machine connectivity. Together, we offer a complete range of Industry 4.0 solutions across all industries. The future requires the agility to adapt quickly to continual digital processes. Our intelligent manufacturing offers embedded expertise, optimized production processes, and workshop Automation: solutions for smart and connected machines.

Service + Success



We take you to new heights

Whether it is Milling, EDM, Laser Texturing or Additive Manufacturing, our Service + Success experts guide you throughout the entire lifecycle of our Machining and Automation tools in order to help you reach your peak performance. Our trusted experts backed by our latest cutting-edge, intelligent Digital Solutions, provide a full range of services (Operational steering, Advanced diagnosis, Certification, Upgrades, Training, Transformation, Financial solutions and Success Packs).



Switzerland

Biel/Bienne
Losone
Geneva
Flawil
Langnau

www.gfms.com
www.gfms.com/ch

Europe

Germany, Schorndorf
www.gfms.com/de

United Kingdom, Coventry
www.gfms.com/uk

Italy, Agrate Brianza - MI
www.gfms.com/it

Spain, Sant Boi de Llobregat
Barcelona
www.gfms.com/es

France, Palaiseau
www.gfms.com/fr

Poland, Raszyn / Warsaw
www.gfms.com/pl

Czech Republic, Brno
www.gfms.com/cz

Sweden, Vällingby
www.gfms.com/system3r

Turkey, Istanbul
www.gfms.com/tr

Americas

USA
Lincolnshire, IL
Chicago, IL
Holliston, MA
Huntersville, NC
Irvine, CA
Woodridge, IL
www.gfms.com/us

Canada, Mississauga ON
www.gfms.com/us

Mexico, Monterrey NL
www.gfms.com/us

Brazil, São Paulo
www.gfms.com/br

Asia

China
Beijing, Shanghai,
Chengdu, Dongguan,
Hong Kong, Changzhou
www.gfms.com/cn

India, Bangalore
www.gfms.com/sg

Japan
Tokyo, Yokohama
www.gfms.com/jp

Korea, Seoul
www.gfms.com/kr

Malaysia, Petaling Jaya
www.gfms.com/sg

Singapore, Singapore
www.gfms.com/sg

Taiwan
Taipei, Taichung
www.gfms.com/tw

Vietnam, Hanoi
www.gfms.com/sg

Optimize the uptime of your equipment with our Customer Services

System 3R's Customer Services is uniquely positioned to help you maximize the availability, value, precision and productivity of your System 3R equipment. Our cost-effective, customer-centric and expert services put your success at the center, ramp up your productivity and ensure predictable, uninterrupted uptime. System 3R's service engineers are your expert partners for a wide range of success-triggering services.

For more info ask your local System 3R dealer.

www.system3r.com

