

AgieCharmilles

LASER P 400

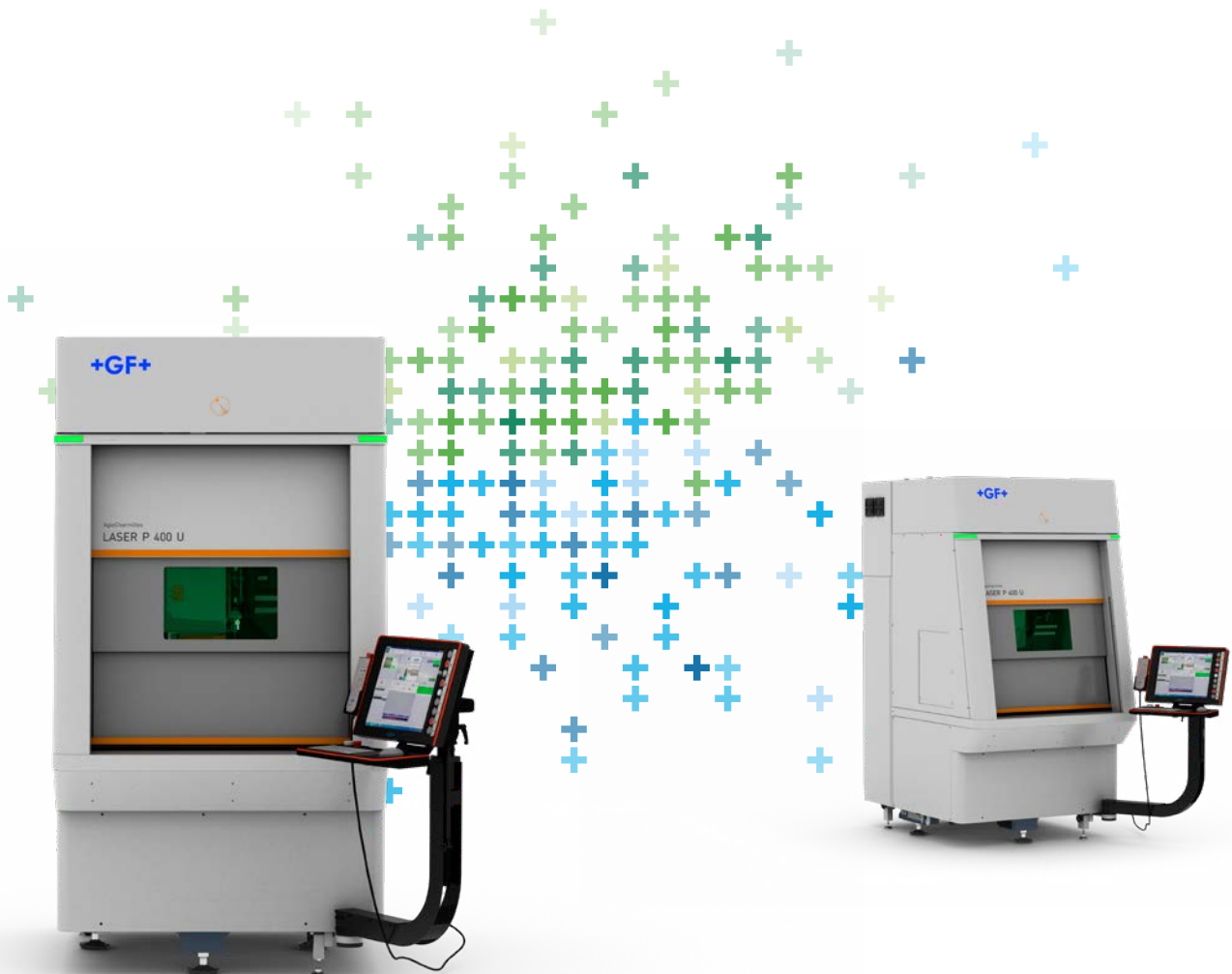

Becoming better every day – since 1802

GF Machining Solutions

When all you need is everything, it's good to know that there is one company that you can count on to deliver complete solutions and services. From unmatched Electrical Discharge Machining (EDM), Laser texturing, Laser micromachining, Additive Manufacturing and first-class Milling and Spindles to Tooling and Automation, all of our solutions are backed by unrivaled customer service and expert GF Machining Solutions training. Our AgieCharmilles, Microlution, Mikron Mill, Liechti, Step-Tec and System 3R technologies help you raise your game—and our digital business solutions for intelligent manufacturing, offering embedded expertise and optimized production processes across all industries, increase your competitive edge.



+ We are AgieCharmilles.
We are GF Machining Solutions.

Contents

4	Make the difference
6	Simplify your machining process
7	All-in-one digitized process
8	Dedicated to your specific needs
9	Higher degree of autonomy
10	New product design dimension
12	Ease of use
13	Technical data
14	GF Machining Solutions

Understanding your expectations is our commitment.

Impeccable performance in a single compact solution

Outstanding quality and efficiency concentrated in the smallest possible footprint and femtosecond Laser technology's integration are the hallmarks of the LASER P 400, an unique texturing, engraving and marking solution. Specially designed for aesthetic and functional texturing of precision parts, including parts for watches and jewelry, small inserts, cutting tools, and micro machined workpieces, the LASER P 400 delivers the highly accurate and repeatable results your discerning customers demand.

Make the difference

Driving your productivity in precision parts production

Ramp up your productivity and part quality with this leading-edge five-axis Laser solution. Use fewer electrodes and cutting tools and eliminate the need for costly raw materials. Machine your part in just one setup, limit human error and significantly simplify your manufacturing process.

Extreme texturing and engraving quality

Get clean, sharp results and absolutely burr-free texturing and engraving with no post-treatment steps required. Using an ytterbium pulsed fiber Laser in combination with a ultrashort pulsed Laser (femtosecond) you achieve exceptionally high quality.

Innovative texturing

Femtosecond Laser technology opens new possibilities for aesthetic nano textures, including ripple effects and spikes, as well as functional textures.

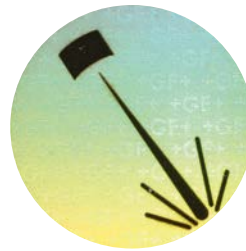

Make the difference

Your versatile solution

Deliver highly accurate and repeatable results your valued customers expect. This one-of-a-kind Laser engraving, texturing and marking solution combines outstanding quality, efficiency, and femtosecond Laser technology in the smallest possible footprint. It is specifically designed for aesthetic and functional texturing of precision parts for watches and jewelry, small inserts, cutting tools and micro machined work pieces.

Scalable solution

Customize your LASER P 400 series machine to your specific needs, thanks to its scalability. Start with a standard configuration and, as your business evolves, add an axis, a nano or ultra-short pulsed Laser, Automation, and System 3R Tooling.

Dual Laser

Combine in live advantages of two lasers (Nano\Femto) into one solution.

Nano and femto

Dual Laser offering more flexibility

Scalable to meet your specific current and future needs

Innovative to open new application horizons with sharp, clean engraving and Nano-level texturing

Robust for optimal dynamics and accuracy

Ergonomic for user comfort and more productivity per square meter



Simplify your machining process

Success in one setup

In a single setup, GF Machining Solutions' leading-edge Laser technology makes it easy for you to machine all of the elements of a bottle cap cavity.

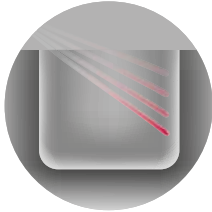

Groove machining

Eliminate the steps required by conventional technologies with five-axis Laser texturing. You do it all in one step.

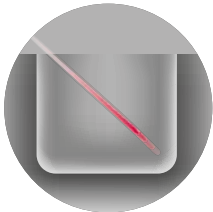

Laser blasting

Achieve outstanding textural homogeneity with fully automated and ready-to-use three- or five-axis Laser blasting.

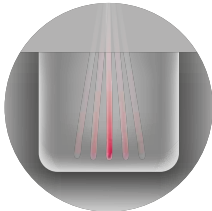

Logos and special textures

Make your own distinctive mark on your work piece, thanks to the unlimited possibilities offered by our Laser texturing technology.



Greater productivity and design possibilities

Fewer human errors

Fewer setups

Lower running costs

3 in 1*

* Laser technology
3 operations in 1 setup



All-in-one digitized process

Simplify your process and achieve infinite repeatability

Limit human error, open new design possibilities and easily texture and engrave your parts, molds and dies—regardless of surface constraints—with our fully digital five-axis process. Fast, accurate and easy surface calculation is built into our Laser solutions to save you time and increase your productivity.

Groove machining process



Milled cavity



Surface of engraving



Volume to be engraved

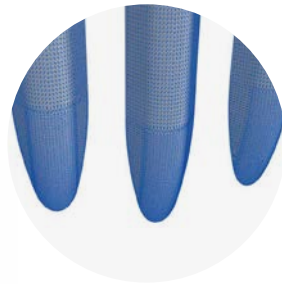

Transformation to mesh



LaserCam
5 axis simulation



Dedicated to your specific needs

One-of-a-kind, all-in-one dual Laser solution

Choose between a fiber or direct Laser and execute your three- or five-axis applications with full confidence that you have a flexible solution dedicated to your specific needs. Only GF Machining Solutions positions you to realize the full potential of Laser texturing technology with an all-in-one dual Laser head.

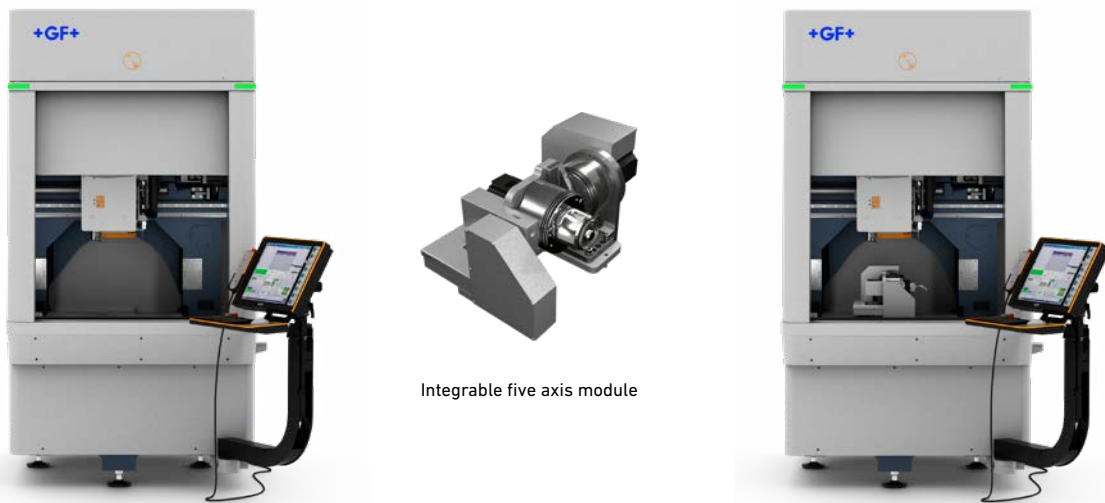

Start
Standard solution

Evolve
Add your
integrable solution

Become unique
Get a unique
five-axis solution

Versatile Laser solution

Second fiber
Ultra-short pulsed Laser (femto)

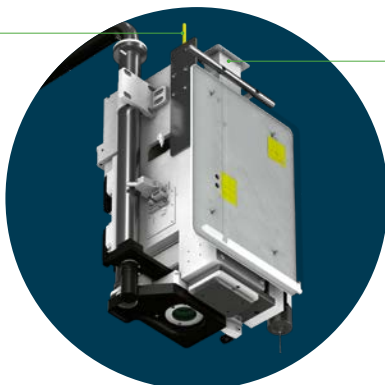

Laser fiber

Standard, all-in-one dual Laser head

Vision system for automatic laser positioning

Renishaw TP1 touch probe

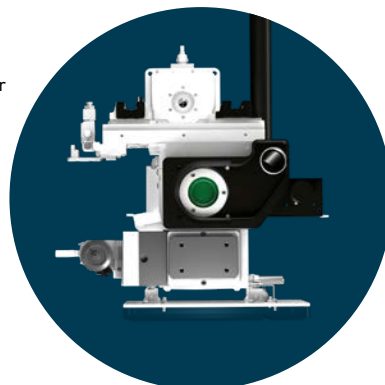

Blowing nozzle

Fast mounting lens holder and exhaust collector

Higher degree of autonomy

Optimize your production

Unproductive time is the enemy of productivity, and System 3R Automation, Tooling and software has the solutions to optimize production by using your machine to its full capacity.

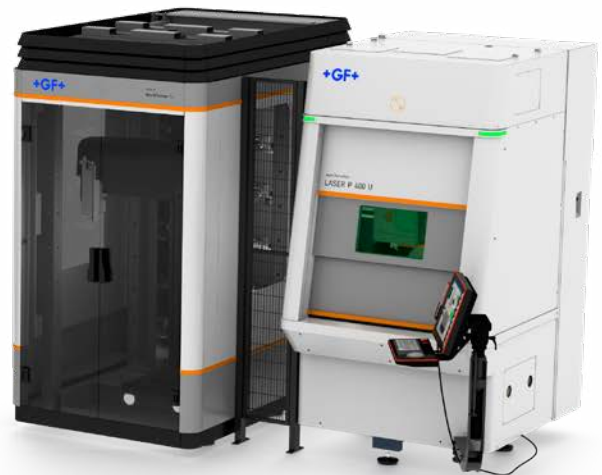
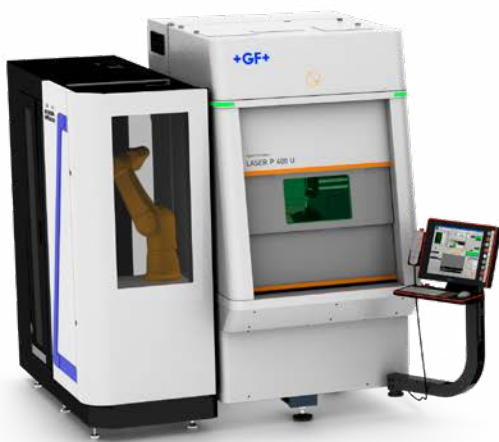

Complete solution
Crevoisier C66 / Laser P 400 (U)



Complete solution
WPT1+ / Laser P 400 (U)

Choice of chucks and Tooling



Three-axis System 3R
Dynafix 280/GPS 240

Five-axis manual rotary 3R system
Macro 54

Five-axis automatic rotary 3R system
Macro 54



New product design dimension

Unlimited possibilities

Texture new materials with confidence

As the market reference in surface texturing, we make it easy for you to engrave a wide variety of materials in three or five axes, with or without a femto Laser source: steel, aluminum, carbide, brass, graphite, copper, ceramic and gemstones. With the femto Laser, you can also engrave glass, sapphire and polymers.

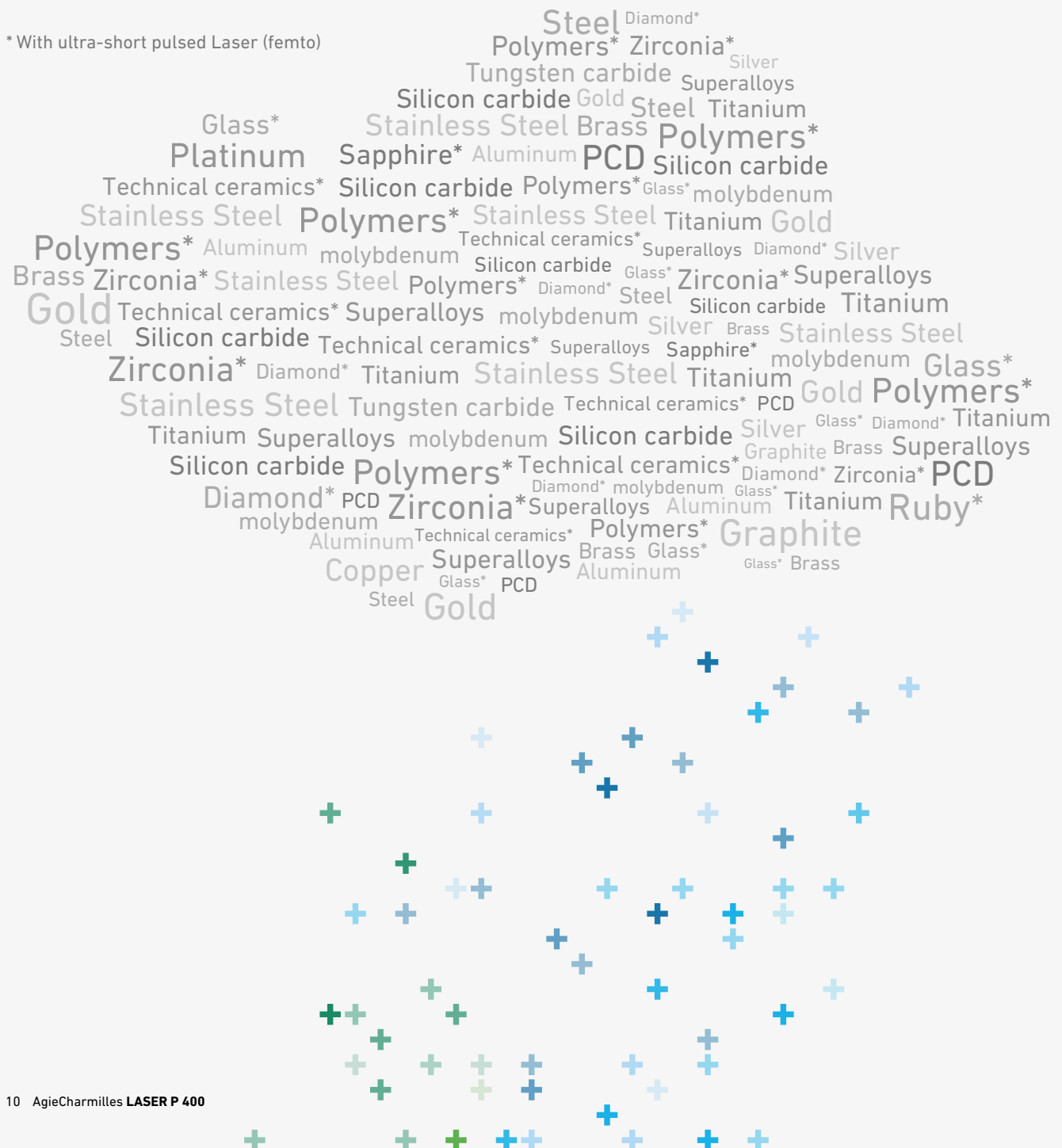

New product design dimension

The femto laser possibilities

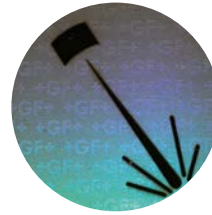
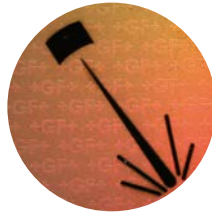

Ripples

New design possibilities with femto laser, colors by light diffraction.



Efficient

Femto second laser allows burr free engravings, limiting Laser post treatment operations

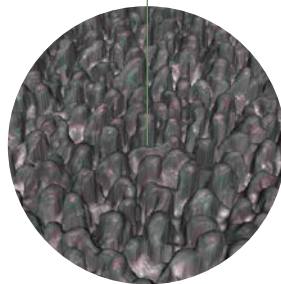

Spikes

New capability with femto laser, deep blacks texture (light trapping)



Standard and cost effective fiber laser solution (Nano second)

Ease of use

Best ergonomic solution for your ease of use



Comfortable utilization

Doors open for easy loading and optimal workpiece access.
Doors closed: the large window provides an excellent view inside the machine for process monitoring.

Technical data

LASER P 400

Dimension of complete equipment *	mm	1230 x 2330 x 2490
Machine weight (machine only)	kg	2400
Floor space (machine only)	m ²	2.04
Maximum workpiece dimensions 3Ax/5Ax	mm	600 x 400 x 250 / Ø 120 x h 120
Maximum workpiece weight 3Ax/5Ax	kg	50/4
Table size	mm	680 x 400
Travel X/Y/Z	mm	600 x 400 x 300
Rotary 4/5 axis **	mm	A 115°-105°/B 360°
Laser sources	W	Multi-Laser sources: nanosecond and/or ultrashort pulsed laser **
Power consumption		Electrical: 3 x 400 Vac + ground; 6 kVA Pneumatic: 6 bars 500 l/min

* Width x depth x height ** Option

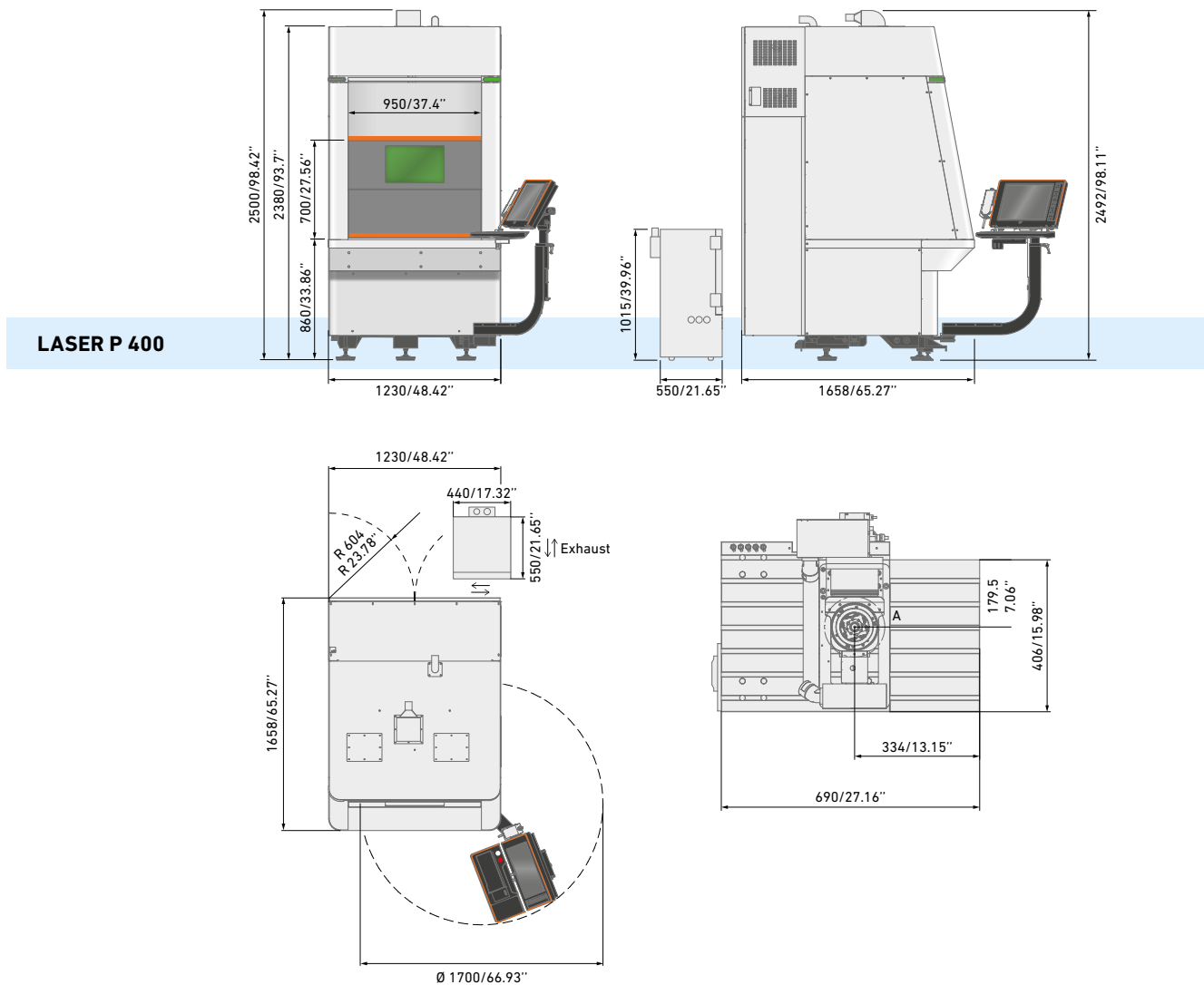

About GF Machining Solutions

Multi-technology solutions provider

Our commitment to you and your specific applications is proven by the value-adding intelligence, productivity and quality delivered by our multi-technology solutions. Your success is our chief motivator. That's why we are continuously advancing our legendary technical expertise. Wherever you are, whatever your market segment and whatever the size of your operation, we have the complete solutions and the customer-centric commitment to accelerate your success—today.

EDM (Electrical Discharge Machining)



Wire-cutting EDM

GF Machining Solutions' wire-cutting EDM is fast, precise and increasingly energy efficient. From ultraprecise machining of miniaturized components down to 0.02 mm to powerful solutions for demanding high-speed machining with respect to surface accuracy, our wire EDM solutions position you for success.

Die-sinking EDM

GF Machining Solutions is revolutionizing die-sinking EDM with features like iGAP technology to dramatically boost machining speed and reduce electrode wear. All of our die-sinking systems offer fast removal and deliver mirror finishes of Ra 0.1 µm (4 µin).

Hole-drilling EDM

GF Machining Solutions' robust hole-drilling EDM solutions enable you to drill holes in electrically conductive materials at a very high speed—and, with a five-axis configuration, at any angle on a workpiece with an inclined surface.

Tooling and Automation



Tooling

Our customers experience complete autonomy while maintaining extreme accuracy, thanks to our highly accurate System 3R reference systems for holding and positioning electrodes and work pieces. All types of machines can easily be linked, which reduces set-up times and enables a seamless transfer of workpieces between different operations.

Automation

Together with System 3R, we also provide scalable and cost-effective Automation solutions for simple, single machine cells or complex, multi-process cells, tailored to your needs.

Milling



Milling

Precision tool and mold manufacturers enjoy a competitive edge with our Mikron MILL S solutions' fast and precise machining. The Mikron MILL P machines achieve above-average productivity thanks to their high performance and Automation. Customers seeking fastest return on investment benefit from the affordable efficiency of our MILL E solutions.

High Performance Airfoil Machining

Our Liechti turnkey solutions enable the highly dynamic manufacturing of precision airfoils. Thanks to the unique performance and our expertise in airfoil machining, you increase productivity by producing at the lowest cost per part.

Spindles

As part of GF Machining Solutions, Step-Tec is engaged in the very first stage of each machining center development project. Compact design combined with excellent thermal and geometric repeatability ensure the perfect integration of this core component into the machine tool.

Software



Digitalization solutions

To drive its digital transformation, GF Machining Solutions acquired symmedia GmbH, a company specialized in software for machine connectivity. Together, we offer a complete range of Industry 4.0 solutions across all industries. The future requires the ability to adapt quickly to continual digital processes. Our intelligent manufacturing offers embedded expertise, optimized production processes, and workshop Automation: solutions for smart and connected machines.

Advanced manufacturing



Laser texturing

Aesthetic and functional texturing is easy and infinitely repeatable with our digitized Laser technology. Even complex 3D geometries, including precision parts, are textured, engraved, microstructured, marked and labeled.

Laser micromachining

GF Machining Solutions offers the industry's most complete line of Laser micromachining platforms optimized for small, high-precision features to meet the increasing need for smaller, smarter parts to support today's leading-edge products.

Laser Additive Manufacturing (AM)

GF Machining Solutions and 3D Systems, a leading global provider of additive manufacturing solutions and the pioneer of 3D printing, have partnered to introduce new metal 3D printing solutions that enable manufacturers to produce complex metal parts more efficiently.

Service + Success



We take you to new heights

Our Success Packs are designed to maximise your return on investment and empower you in your quest for success across all industrial segments. Our subscription packs feature a comprehensive range of services that guarantee the access and support you need to get the most out of your assets today, while preparing for the challenges of tomorrow. Our trusted experts backed by our latest cutting-edge, intelligent Digital Solutions, provide a full range of services.

eCatalog

Keep your equipment operating at peak precision and performance with our wide range of certified consumables and original wear parts. Our online catalog has it all (ecatalog.gfms.com).



Our locations

Switzerland

Headquarters
Biel/Bienne +++

Losone +++
Geneva ++
Langnau ++

Europe

Schorndorf, Germany ++
Coventry, United Kingdom ++
Agrate Brianza (MI), Italy ++
Barcelona, Spain ++
Marinha Grande, Portugal +
Massy, France +
La Roche Blanche, France +
Lomm, Netherlands ++
Altenmarkt, Austria ++
Warsaw, Poland ++
Brno, Czech Republic ++
Budapest, Hungary ++
Vällingby, Sweden +

America

USA
Lincolnshire (IL) ++
Chicago (IL) ++
Huntersville (NC) ++
Irvine (CA) ++

Toronto (Vaughan), Canada ++
Monterrey, Mexico ++
São Paulo, Brazil +
Caxias do Sul, Brazil +

Asia

China
Beijing +++
Changzhou ++
Shanghai ++
Chengdu ++
Dongguan ++
Hong Kong +

Yokohama, Japan ++
Taipei, Taiwan +
Taichung, Taiwan ++
Seoul, Korea ++
Singapore, Singapore ++
Petaling Jaya, Malaysia ++
Bangalore, India ++
Pune, India +
Hanoi, Vietnam ++

+ Plant ++ Center of Demonstration +++ Sales company

At a glance

We enable our customers to run their businesses efficiently and effectively by offering innovative Milling, EDM, Laser, Additive Manufacturing, Spindle, Tooling and Automation solutions. A comprehensive package of services completes our proposition.

www.gfms.com



© GF Machining Solutions Management SA, 2024
The technical data and illustrations are not binding.
They are not warranted characteristics and are
subject to change.